

Ø20KNURLING ADJUSTMENT KONB
DO NOT SCREW/UNSCREW PAST EXTENTS

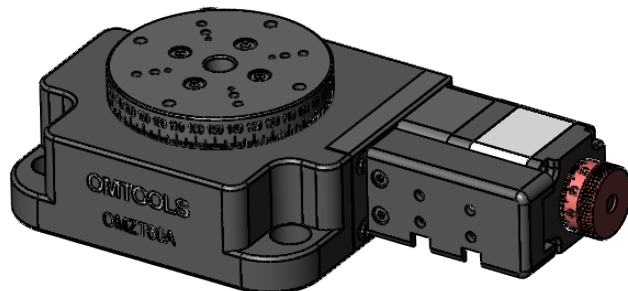
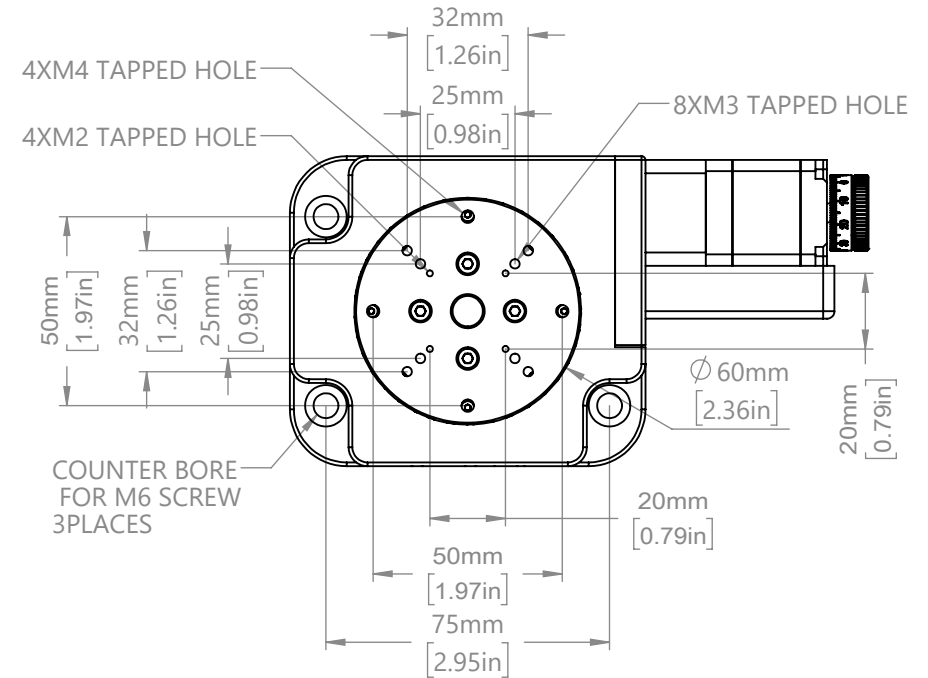
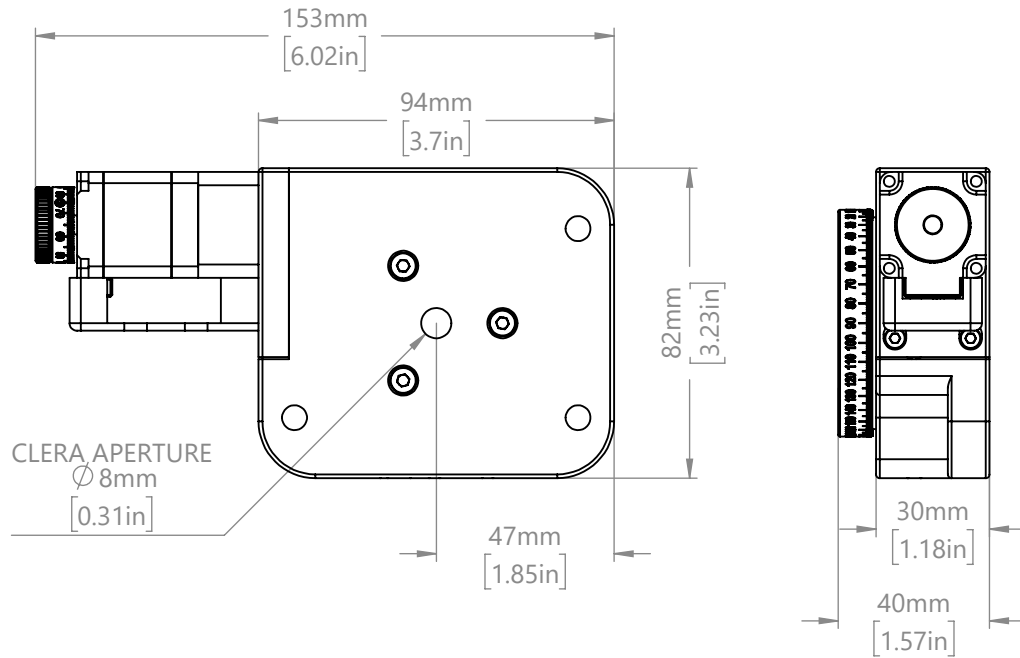

DRAWING PROJECTION				<h1>OMTOOLS</h1>	
REV	A0	<p>OMZT60A</p>			
DRAWN	HSY			WEIGHT	SCALE
DATE	2021/11/11	0.76kg	1:2		
FOR INFORMATION ONLY NOT FOR MANUFACTURING PURPOSES					